

# SIWRDCP-V7

## Preconfigured Signum Complete Scale

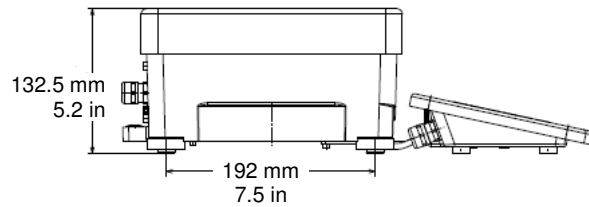

### SPECIFICATIONS:

Weighing Capacity	6 kg	Platform Size (WxD)	13.7" x 9.4"
Readability	0.2g	Dimensions (WxD)	13.7" x 16.5"
Linearity	± 0.4g.	Displ. Dim. (WxHxD)	9.5" x 2.5" x 7"
Reproducibility	± 0.2g	Display Cable Length	6 feet
Response Time	< 1 seconds	Net Weight	26 lb.
Operating Temp.	10°C to +40°C	Type of Display	Backlit 14-segment
Protection Rating	IP 65	Overload Capacity	300 kg.

### FEATURES:

- The new Signum from Sartorius** is a compact industrial scale that offers exceptional performance features and is very easy to operate. Flexible and ergonomic thanks to adaptable mounting options of the control unit in a slim-line design.
- Application Level 1 – Basic Weighing**  
 Large keys with positive click action  
 Large backlit 14-segment display
- IP65 Protection Rating**  
 The IP 65 protection rating means the scale is dust-tight and with low-pressure water jet protection. This feature makes these scales suitable for use in some of the harshest industrial environments.
- Optional Additional Interfaces**  
 Ethernet TCP/IP  
 RS232/422/485  
 Profibus-DP  
 Analog: 4-20mA, 0-20mA, 0-10V 16 Bit  
 Digital I/O: 5 in-5 out Opto 130
- RS232 Data Interface**  
 The SIWRDCP-V7 scales come with a bi-directional interface, which allows for simple connection to a printer or computer for easy data acquisition and automation capabilities. 25-pin D-sub female connector

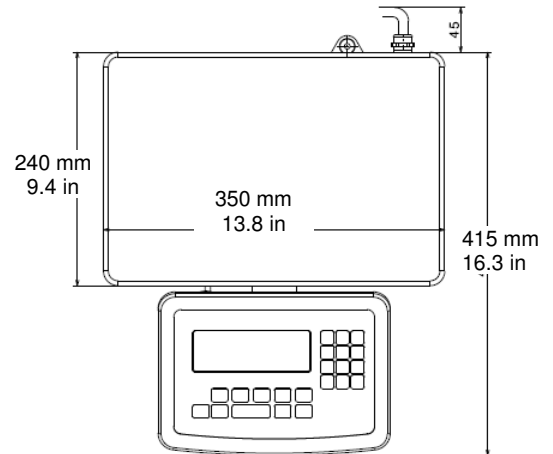

Sartorius Corporation  
 131 Heartland Boulevard  
 Edgewood New York 11717  
 Toll Free: (800) 635-2906  
 ☎ (631) 254-4249  
 Fax (631) 254-4252